



- › Innovatives Design
 - › Highest-Qualität in Material und Verarbeitung
 - › Weltweit größte Auswahl an Aluminiumprofilen und -oberflächen
 - › Unübertroffen stabil und leicht zu montieren
 - › Der Klassiker für die prägnante Bildrahmung
-
- › Innovation in design and colours
 - › Highest quality in material and workmanship
 - › The world's largest selection of aluminium framing mouldings and finishes
 - › Unbeatable in stability and ease in assembly
 - › The classic moulding for expressive framing

ÜBERSICHT –
FARBEN UND PROFILE
SPECIFIER –
COLOURS AND PROFILES







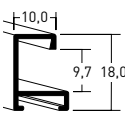
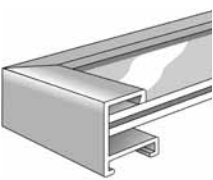
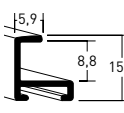

222

nielsen®

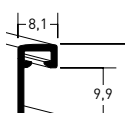
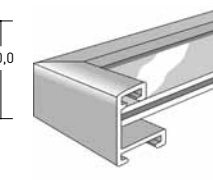
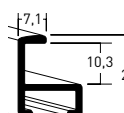
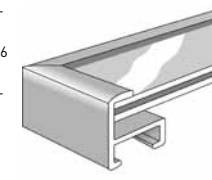
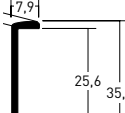
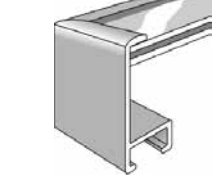
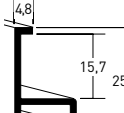
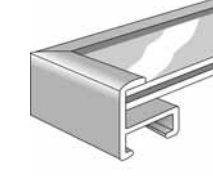
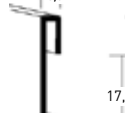
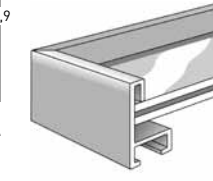
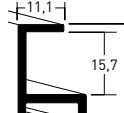
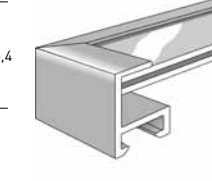
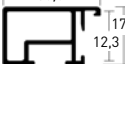
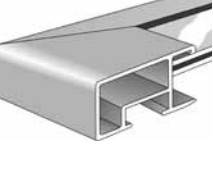
▣ NielsenBainbridge

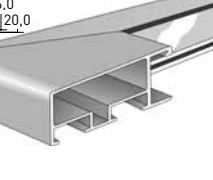
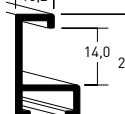
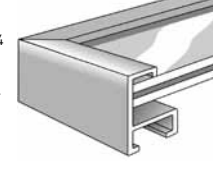
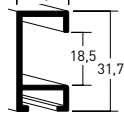
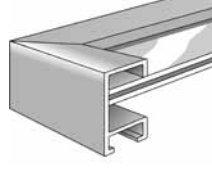
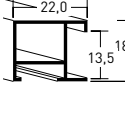
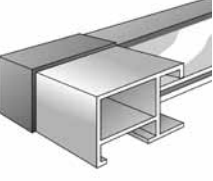
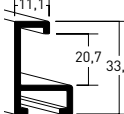
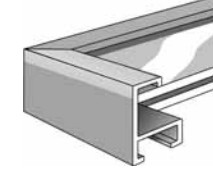
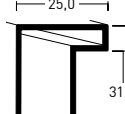
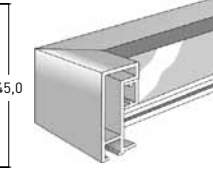
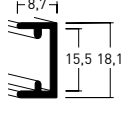
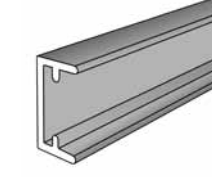
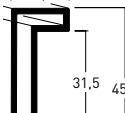
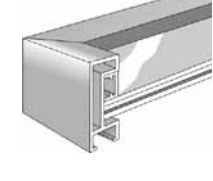
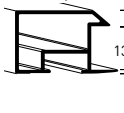
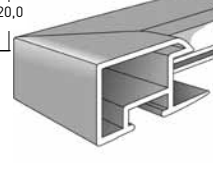
Aluminium | Profile flach | Flat profiles

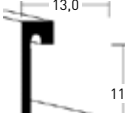

	A	B	C	D
1	# 3 14 Farben Colours  	# 4 14 Farben Colours  	# 8 8 Farben Colours  	# 11 18 Farben Colours  
2	# 22 3 Farben Colours  	# 33 3 Farben Colours  	# 34 4 Farben Colours  	# 50 4 Farben Colours  
3	# 69 4 Farben Colours  	# 79 3 Farben Colours  	# 93 4 Farben Colours  	# 94 4 Farben Colours  
4	# 97 9 Farben Colours  	# 221 4 Farben Colours  	# 222 3 Farben Colours  	# 223 3 Farben Colours  
5	# 224 3 Farben Colours  	# 262 10 Farben Colours  		
6	# 273 4 Farben Colours  			

Aluminium | Profile rund | Profiles round top





	E	F	G	H
1	# 7 10 Farben Colours	# 15 42 Farben Colours	# 24 9 Farben Colours	# 29 3 Farben Colours
2	# 62 14 Farben Colours	# 71 6 Farben Colours	# 75 8 Farben Colours	# 82 10 Farben Colours
3	# 85 5 Farben Colours	# 87 5 Farben Colours	# 269 18 Farben Colours	# 270 18 Farben Colours



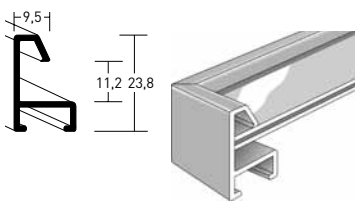
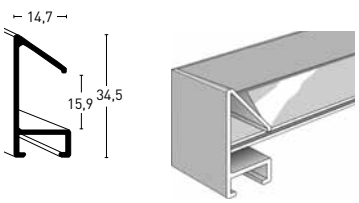
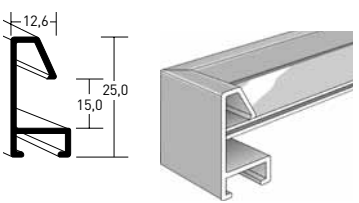
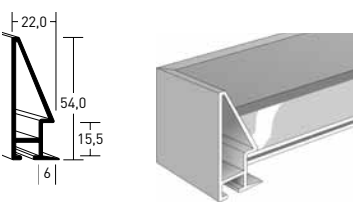
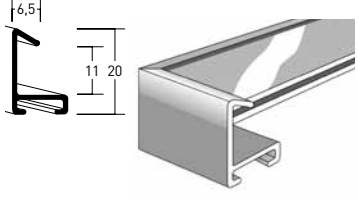
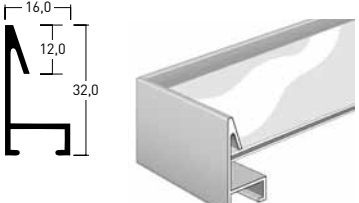

Aluminium | Profile Gallery | Profiles Gallery



	I	J	K	L
1	# 23 3 Farben Colours 	# 51 21 Farben Colours 	# 53 3 Farben Colours 	# 56 6 Farben Colours 
2	# 217 11 Farben Colours 	# 272 4 Farben Colours 		

Aluminium | Profile Schattenfuge | Floater Profiles

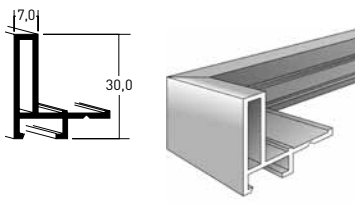
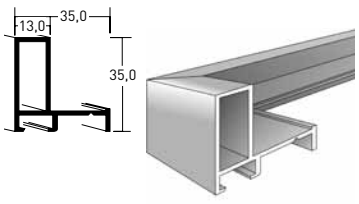
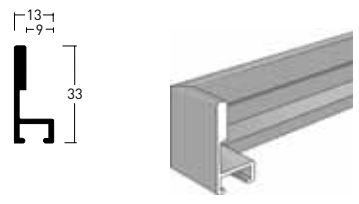

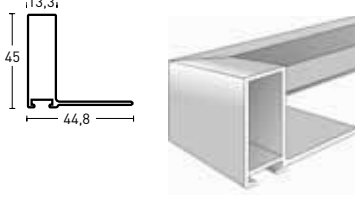
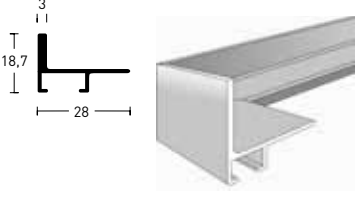
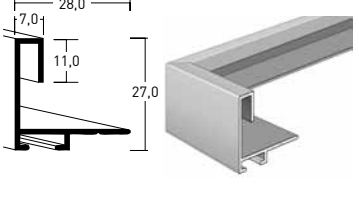
	I	J	K	
5	# 26 2 Farben Colours 	# 28 2 Farben Colours 	# 214 2 Farben Colours 	
6	# 227 2 Farben Colours 	# 230 2 Farben Colours 	# 271 4 Farben Colours 	

Aluminium | Design & Style



	M	N	O	P
1	# 40 1 Farbe Colour 	# 42 1 Farbe Colour 	# 215 + 216 3 Farben Colours 	# 215 3 Farben Colours
2	# 220 6 Farben Colours 	# 225 20 Farben Colours 	# 229 9 Farben Colours 	



Aluminium | Wandboard



M

5 **# 254** 1 Farbe | Colour



Aluminium | Eloxal- und Lackfarben | Finishes



056 Weiß glanz | Glossy White
4, 11, 15, 50

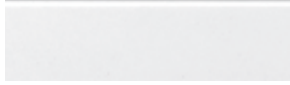

027 Weiß matt | White matt
3, 51, 93, 94, 217, 262, 271, 272, 273



212 Reflex Silber | Reflex Silver
221

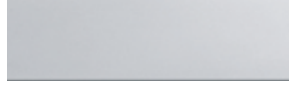

003 Silber glanz | Polished Silver
4, 7, 8, 11, 15, 22, 33, 34, 40, 42, 50, 51, 56, 62, 71, 75, 82, 85, 215, 216, 217, 220, 222, 223, 224, 225, 262, 269, 270, 271, 272, 273



004 Silber matt | Frosted Silver
3, 4, 7, 8, 11, 15, 22, 23, 26, 28, 29, 33, 34, 50, 51, 53, 56, 62, 71, 75, 82, 85, 93, 94, 214, 215, 216, 217, 222, 223, 224, 227, 230, 254, 262, 269, 270, 271, 272, 273



006 Contrastgrau glanz | Contrast Grey
4, 8, 11, 15, 51, 56, 85, 217, 220, 225, 262, 269, 270



149 Florentiner Silber natur | Florentine Silver Natural
51



233 Stahlgrau | Steel Grey
51



256 Stahlgrau matt | Frosted Steel Grey
62, 82, 262



282 Schwarz silber | Black Silver
26, 28



469 Struktur Satin Silber | Brushed Satin Silver
24



218 Brushed Silber | Brushed Silver
225, 269, 270



414 Struktur Satin German Silber | Brushed Satin German Silver
24



154 Florentiner Grau | Florentine Grey
3, 51, 97, 217



257 Nickel | Nickel
51, 69, 79



255 Edelstahl | Bright Steel
69, 79



223 Brushed Grau | Brushed Grey
225, 269, 270



254 Stahl | Natural Steel
69, 79



019 Platin matt | Platin
3, 4, 11, 15, 23, 51, 53, 56, 62, 71, 82, 93, 94, 217, 269, 270



009 Zinn glanz | Pewter
11, 15, 262



113 Anthrazit matt | Anthracite
4, 11, 15, 51



021 Schwarz matt | Black matt
3, 4, 7, 8, 11, 15, 22, 23, 33, 50, 51, 53, 56, 62, 71, 75, 82, 85, 93, 94, 214, 217, 222, 223, 224, 269, 270



016 Eloxal Schwarz glanz | Jet-Polished Black
4, 7, 8, 11, 15, 51, 62, 71, 75, 82, 85, 220, 225, 262, 269, 270

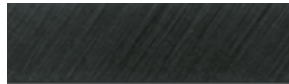

156 Florentiner Schwarz | Florentine Black
3, 9, 51, 97



250 Eloxal Schwarz matt | Matt Anodic Black
34, 215, 216, 227, 230, 271, 272, 273



421 Struktur Satin Schwarz | Brushed Satin Black
24



316 Struktur-Schwarz | Brushed Black
7, 82, 87



222 Brushed Schwarz | Brushed Black
225



471 Struktur Satin Schiefer | Brushed Satin Slate
24



306 Struktur Grau | Brushed Frosted Ceanothus
7, 15, 29



150 Florentiner Silber | Florentine Silver
3, 51, 81, 97, 217



011 Champagner matt | Champagne
4, 8, 11, 15



234 German Silver | German Silver
220



017 German Silver matt | German Silver
34, 51, 56



115 Maisgelb matt | Golden Yellow
15



118 Sonnenblume | Sunflower
15



001 Gold | Polished Gold
4, 7, 8, 9, 11, 15, 22, 51, 62, 75, 82, 217, 220, 269, 270



000 Hellgold glanz | Pale Gold
71



002 Gold matt | Frosted Gold
4, 8, 11, 15, 62, 217, 269, 270



151 Florentiner Gold | Florentine Gold
3, 51, 97



259 Messing | Laiton
69



317 Struktur-Gold | Brushed Gold
87



423 Struktur Satin Antik Gold |
Brushed Satin Gold
24



155 Florentiner Amber |
Florentine Amber
3, 97



220 Brushed Gold |
Brushed Gold
225



167 Florentiner Altsilber |
Florentine Brass
97



018 Walnuss glanz | Walnut
11, 15, 220



165 Florentiner Walnuss |
Florentine Walnut
51, 97



251 Walnuss matt | Walnut matt
62



318 Struktur-Walnuss |
Brushed Walnut
7, 15, 87



475 Struktur Satin Braun |
Brushed Satin Chocolate
24

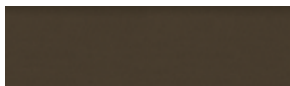

022 Braun matt | Brown
11



205 Brushed Dunkelbraun |
Brushed Darkbrown
225



229 Umbra | Umbra
262



211 Brushed Umbra |
Brushed Umbra
225, 269, 270



152 Florentiner Bronze |
Florentine Bronze
97



221 Brushed Amber |
Brushed Amber
225



120 Mango | Mango
15



217 Brushed Citrin |
Brushed Citrin
225, 269, 270



216 Brushed Dunkelocker |
Brushed Darkocher
225



210 Brushed Turmalinrot |
Brushed Tourmalinred
225, 269, 270

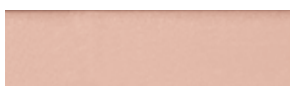

008 Bronze matt | Copper Mat
11, 15



033 China rot matt | Red
4



046 Rubinrot matt | Brick
11



209 Brushed Rubinrot |
Brushed Rubyred
225, 269, 270



211 Tornado Rot |
Tornado Red
221



117 Feuerrot matt | Hot Fire Red
15, 51, 217



098 Ferrari glanz | Ferrari
15, 75



069 Cherry glanz | Cherry Red
15



228 Granatrot | Garnetred
262



208 Brushed Granatrot |
Brushed Garnetred
225



135 Rot matt | Hot Cherry
15, 51



244 Rosso matt | Dogwood
15, 62



474 Struktur Satin Caramel |
Brushed Satin Caramel
24



473 Struktur Satin Champagner |
Brushed Satin Champagne
24



219 Brushed Pyrit |
Brushed Pyrit
225, 269, 270



013 Sterling matt |
Frosted Sterling Blush
15



106 Blaubeere glanz | Blueberry
15



082 Capri glanz | Capri
15



101 Mauritius glanz | Hawaii
4, 15



203 Brushed Saphir I
Brushed Saphir
225, 269, 270



214 Reflex Lila I
Reflex Purple
221



108 Dunkelblau matt I
Persian Sapphire
15



109 Königsblau matt I
Paradise
15



242 Azzurro matt I
Iris
15, 62



241 Blu matt I
Ceanothus
3, 15, 51, 62, 82



476 Struktur Satin Saphir I
Brushed Satin Sapphire
24



330 Struktur-Topaz I
Soft Moonshadow
7, 15



168 Florentiner Cobalt I
Florentine Cobalt
9, 97



070 Nachtblau glanz I
Midnight Blue
15

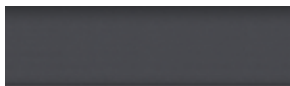

040 Marineblau matt I
Admiralty
11



309 Struktur-Zinn I
Brushed Pewter
87



153 Florentiner Zinn I
Florentine Pewter
3, 81



010 Zinn matt I
Mist
4, 11, 15, 62, 82, 262



327 Struktur Mercury I
Brushed Mercury
7, 15, 29, 87



246 Toscana matt I
Myrtle
15, 62



224 Brushed Opal I
Brushed Opal
225, 269, 270



206 Brushed Oakgrün I
Brushed Oakgreen
225



207 Brushed Smaragdgrün I
Brushed Emeraldgreen
225, 269, 270



215 Cyber Green I
Cyber Green
221



127 Limone I
Lemonade
15



286 Pearl Mercury I
Pearl Mercury
15, 75



285 Pearl Gold I
Pearl Gold
15



284 Pearl Silber I
Pearl Silver
15, 75



287 Pearl Grau I
Pearl Grey
15



